

Frameworks Manufacturing, Inc.
Sliding Door Diagrams

Step #1
Fixed Panel Installation

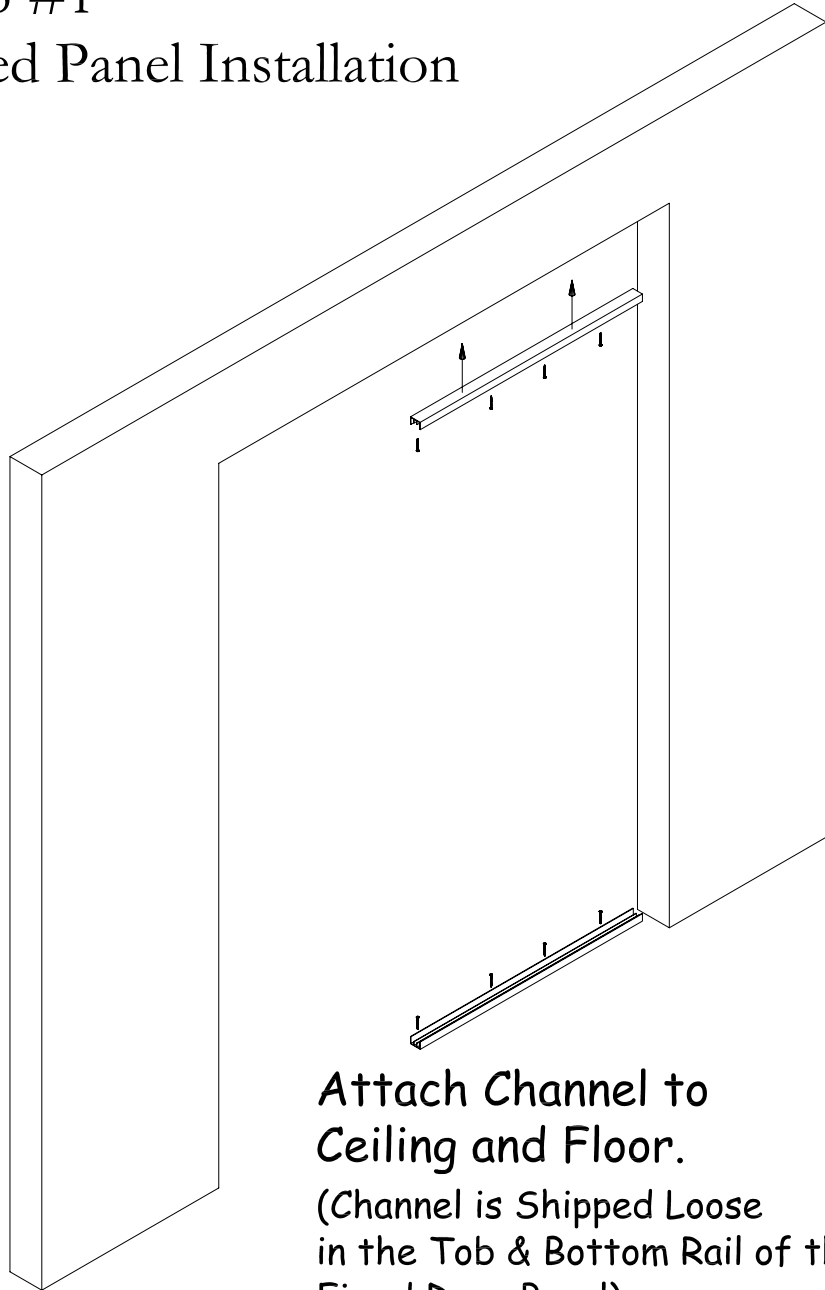

**Attach Channel to
Ceiling and Floor.**
(Channel is Shipped Loose
in the Top & Bottom Rail of the
Fixed Door Panel)

Step #2

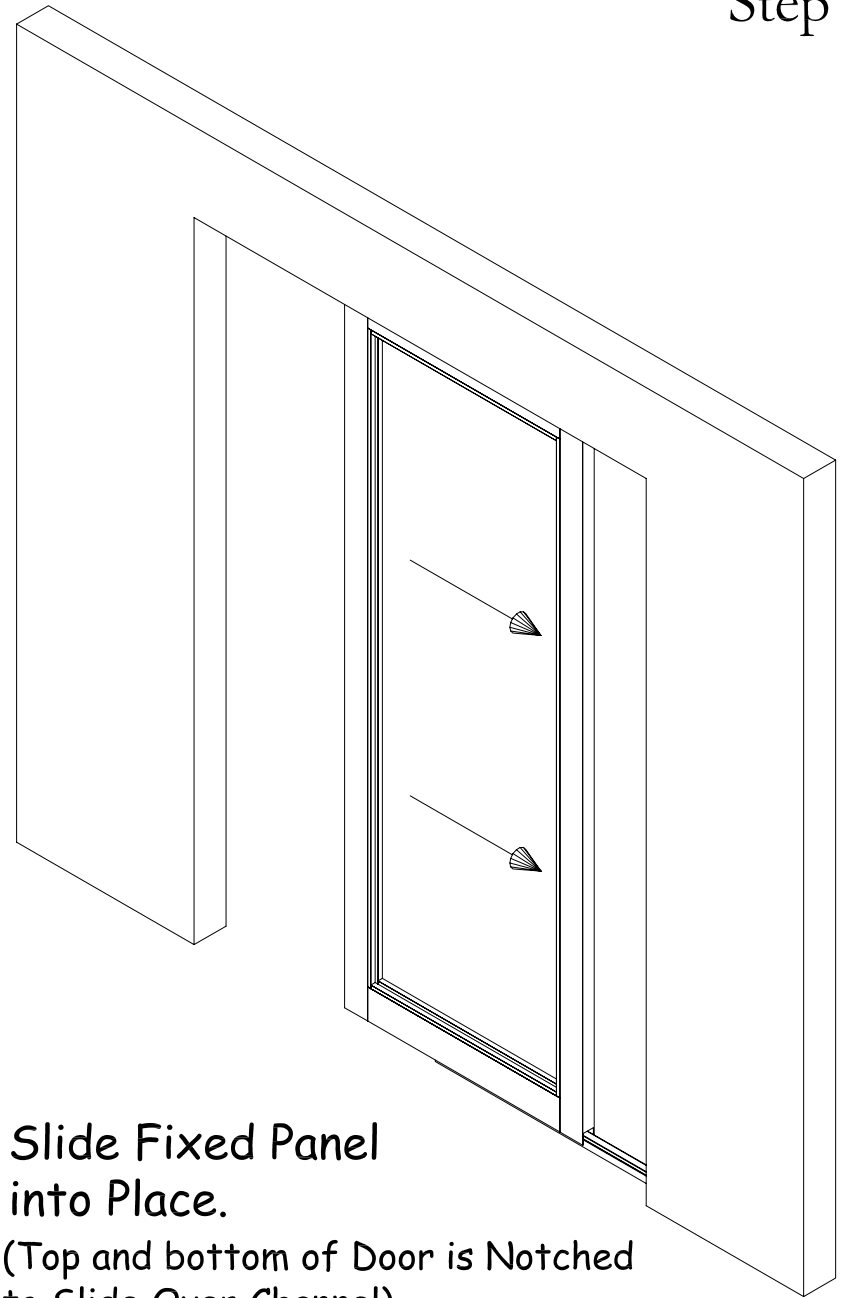

**Slide Fixed Panel
into Place.**
(Top and bottom of Door is Notched
to Slide Over Channel)

Frameworks Manufacturing, Inc.
Sliding Door Diagrams

Step #3

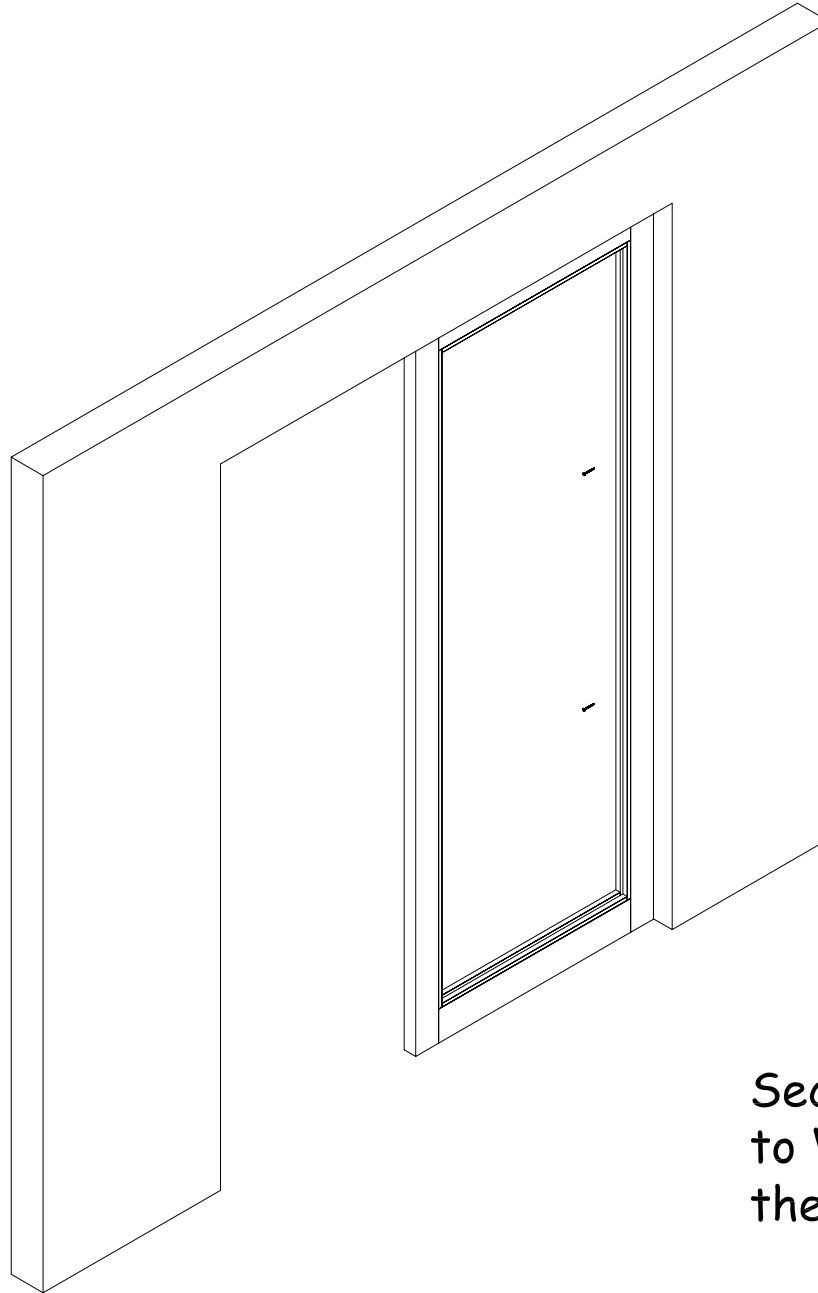

Secure Fixed Panel
to Vertical Wall Using
the Provided Screws

Frameworks Manufacturing, Inc.
Sliding Door Diagrams

Step #4

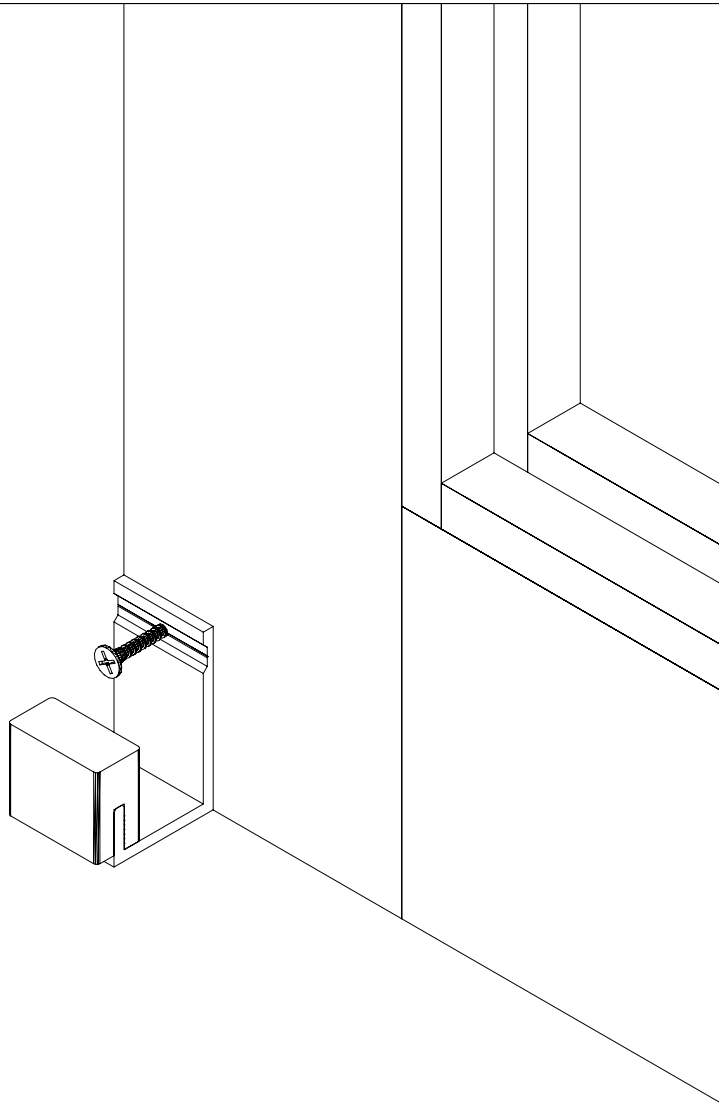

Attach Door Guide
to Fixed Panel.

Step #5

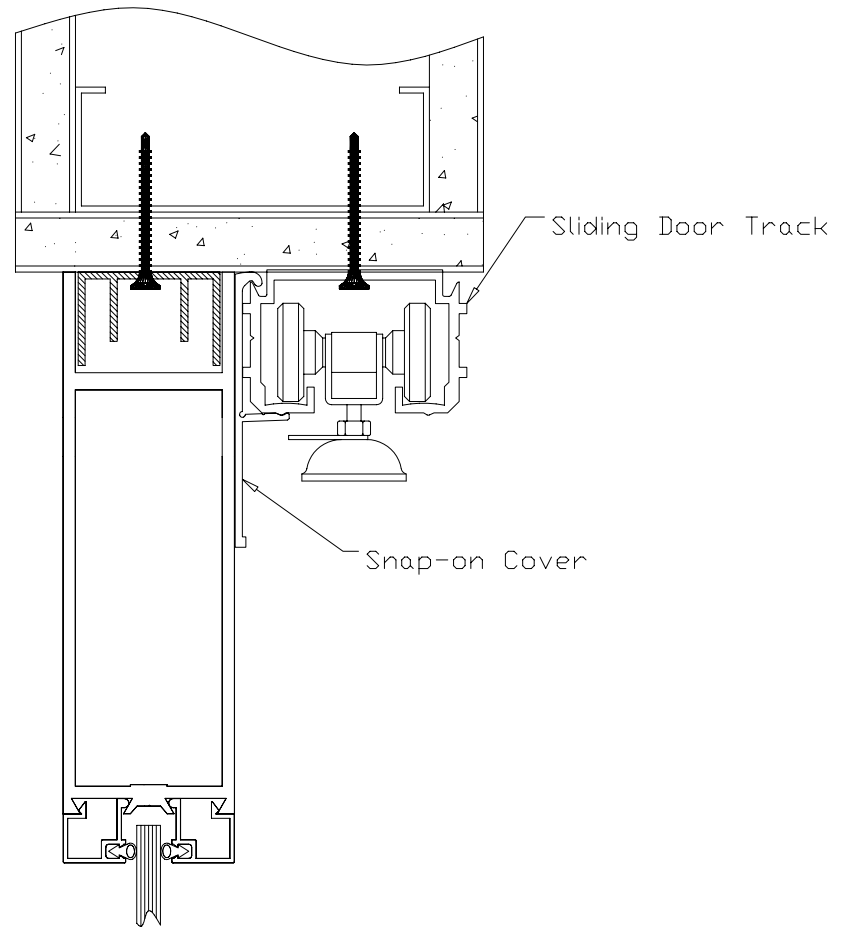

Install Sliding Door Track With
Snap-on Cover to Head Condition.
(Rollers are Pre-Installed in Track)

Frameworks Manufacturing, Inc.
Sliding Door Diagrams

Step #6

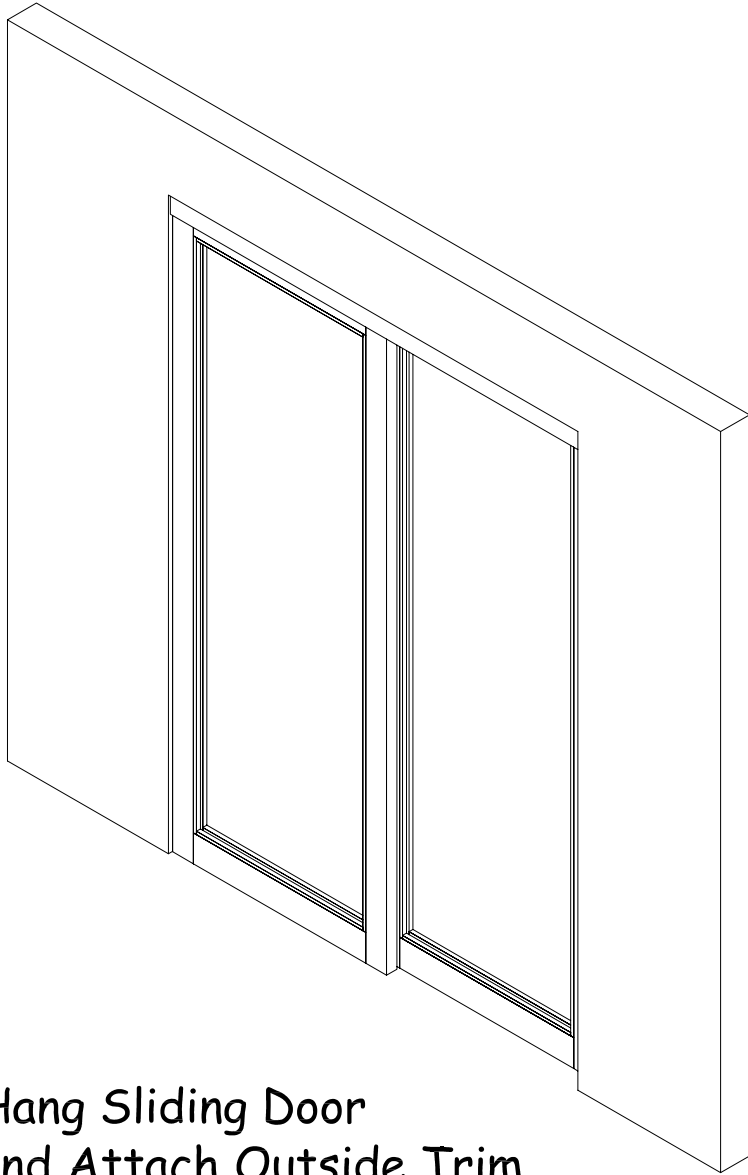

Hang Sliding Door
and Attach Outside Trim
Cover on Track

Completed Head Detail

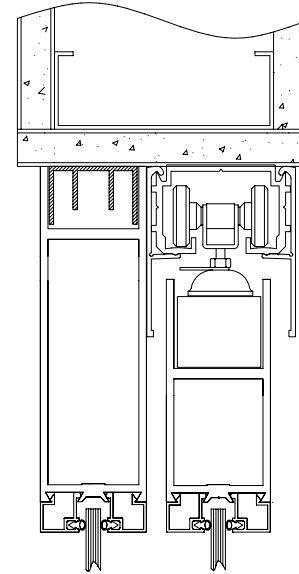

Completed Base Detail

